

# CT20602

## USB Power Delivery 3.1 Physical Layer

### Status

- Silicon-Proven
- Fully characterized
- USB compliance
- In mass production

### Deliverables

- Datasheet
- GDS2 and LVS Netlist
- Footprint (.LEF)
- HDL models
- RTL netlist
- Test Specifications
- Integration guidelines

### Applications

- USB-PD Interface
- Active Cables

### Features

- USB Power Delivery 3.1-certified
- Auto GOOD-CRC and Auto Retry
- Configurable Dual-Role, Source or Sink only
- Includes Fast-Role Swap Transceiver
- Dedicated Registers-sets and/or TCPC compliant
- Low Power
- No external components
- Voltage and current references, test infrastructures, included

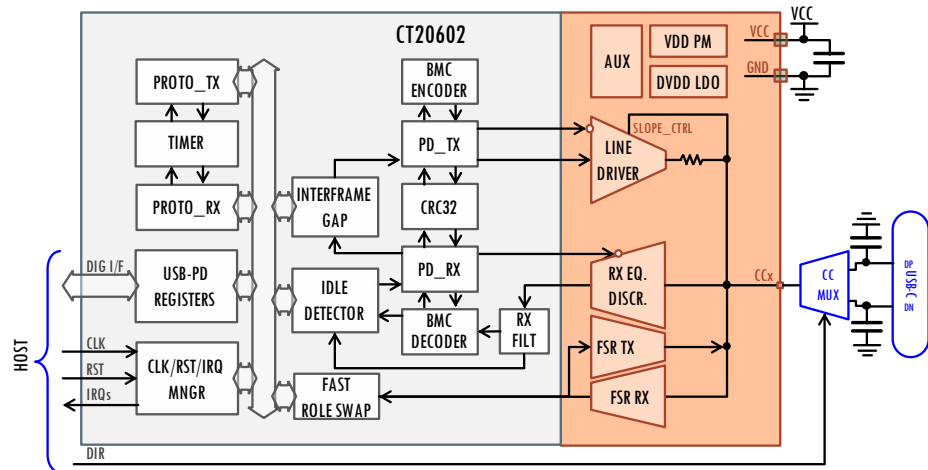

### Description

CT20602 is a complete USB Power Delivery 3.1 Physical Layer. It also implements that part of the USB Power Delivery 3.1 Protocol Layer which are defined in the Type-C Port Controller specification, to simplify the integration with the Power Delivery Host Controller.

The Analog Front-End implements the slew-rate controlled transmitter block, the receiver block (fully compatible with the entire directives for line noise and cable DC offset and transients) and the Fast Role Swap transceiver.

The digital section of the PHY:

- Formats and sends messages,
- Formats and sends signals
- Receives and validates messages
- Receives signals
- detects incoming HardReset or CableReset signals
- Grants the inter-frame gap
- Supports SOP, SOP' and SOP'' and messages
- Supports BMC BIST modes
- Receive and Send Fast Role Swap signal

CT20602 interfaces with the Host by means of a set of standardized registers which buffers USB-PD data packets and provides commands to control operations.

# USB-C IPs

# Frequently-Asked Questions

**Q: Which kind of IC products I can develop using Canova Tech USB-C silicon IPs solution?**

**A:** Among others, here're some product examples you can develop with our USB-C silicon IPs:

## Type-C Port Controller (TCPC)

The bundle of the CT20602 plus the CT20601 can be used to develop a complete Type-C Port Controller (TCPC) Integrated Circuit. The USB-PD Protocol runs in the Type-C Port Manager MCU (TCPM) which can be integrated in the same IC (USB-PD Controller) or acts as companion IC. Other system related function like the Power Management IC (PMIC) or USB-C custom applications can be integrated in the same IC or in a companion IC.

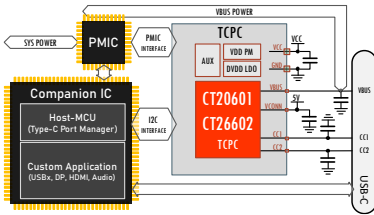

## USB-PD Controller

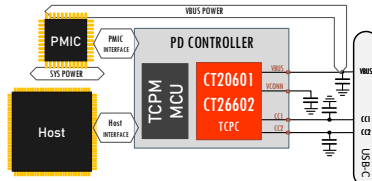

## USB-PD PMIC

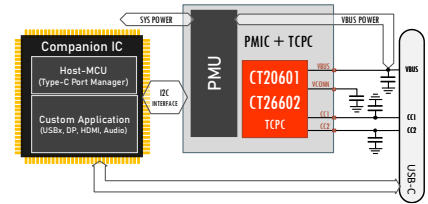

## eUSB2 Repeater

The CT20603 can be used to develop a single-chip eUSB2 Repeater which connects, on one side to the Companion SoC by means of the eUSB2 link and, on the other side to the USB-C plug.

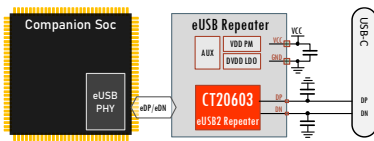

## e-Marker

The CT20602 can be used to develop a complete e-MARKER IC by adding a customized e-MARKER Protocol stack RTL core thus eliminating the need of a companion microcontroller in the system.

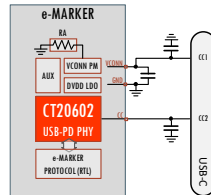

## Active Cable

The USB-PD Protocol runs in a microcontroller (TCPM) which can be integrated, together with the ACTIVE CABLE application in the same IC or as companion IC.

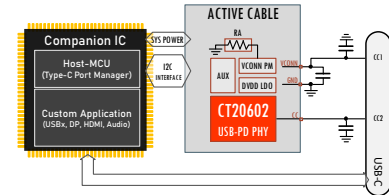

## TCPC/USB-PD Ctrl/USB-PD PMIC + eUSB2 Repeater

Add on top of the TCPC, the USB-PD Ctrl or the USB-PD PMIC the CT20603 if you need to connect with an eUSB port of a System-on-Chip.

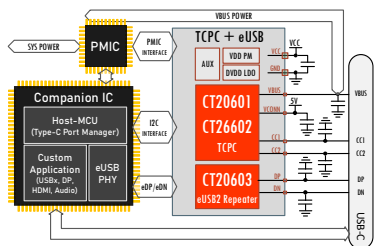

## TCPC/USB-PD Ctrl/USB-PD PMIC + USB Billboard

Add on top of the TCPC, the USB-PD Ctrl or the USB-PD PMIC the CT25100 if you need to perform an USB Billboard function without the use of a companion MCU running the USB stack.

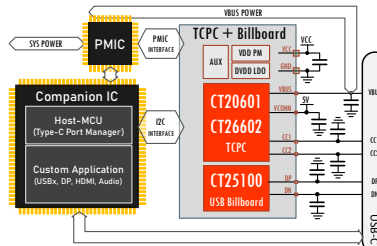

## Active Cable + USB Billboard

Add on top of the Active Cable the CT25100 if you need to perform an USB Billboard function without the use of a companion MCU running the USB stack.

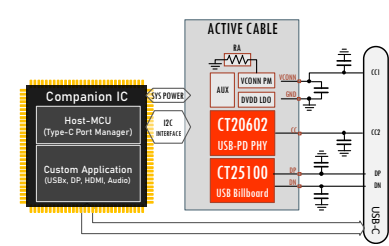

**Q: May I ask Canova Tech to develop custom and dedicated analog and/or digital on top of the IPs?**

**A:** Yes, you can. Our business model includes custom and dedicated Design Services to facilitate the integration of our IPs into your chip architecture. This business model includes the possibility for you to assign Canova the responsibility for design of a complete integrated circuit (GDS IP) based upon our IPs and your requirements.

**Q: Which options do I have for licensing the Canova Tech USB-C silicon IPs solution?**

**A:** You can have several licensing options which includes:

- single-use/multiple-use license: the IPs (single or in bundle) are delivered as object-code (or source-code + know-how transfer) and licensed for the use on a well-defined product code (single-use) or for unlimited product codes (multiple-use).
- manufacturing license: here Canova Tech can develop your entire product, based upon our IPs (single or in bundle) and your product specifications. The GDS IP is licensed and delivered to you (including all necessary documentation and support) for you to manufacture your product and brand it.

**Q: What kind of Support and IP Maintenance will I get from Canova?**

**A:** You will get all required Support and IP Maintenance to ensure proper IP integration into your products for 12 months following the IP licensing. You can then subscribe, at your option, annual renewals of the Support and Maintenance agreement.